



# RFBM-2M

EN Energy gateway



# iNELS

RF Control

02-5/2018 Rev.2

## Characteristics

- The energy gateway is a central device for assessing energy consumption (electricity, water, gas).
- It acts as an interface between the pulse converter RFTM-1 and your smartphone. The Energy Gateway allows you to connect up to 8 pulse transducers.
- Connection to the data network is made by means of LAN Ethernet connector or wirelessly via a Wi-Fi network.
- The monitored data is stored inside the unit.
- Up to 4 tariff meter readings of electricity consumption, which can be displayed in the form of kWh or financial costs.
- Option of setting reaction to specific consumption to switch the output on or off (RFS-6x and CU3).
- The unit enables connecting up to three current transformers CT50 to each other for measuring electricity.
- 3-module design, mounted on a DIN rail into the switchboard.
- The supply includes an internal antenna AN-I, if the unit is installed in a metal switchboard, you can use the external antenna AN-E to enhance the signal.
- The device supply voltage is provided from monitored phases.
- Range up to 100 m (in open space), if the signal between the controller and the user is weak, use the signal repeater RFRP-20 or protocol component RFIO<sup>2</sup> that support this feature.
- Communication frequency with bidirectional protocol iNELS RF Control.

- In order to communicate with the gateway, it must be connected to the local network using the RJ45 Ethernet connector or wirelessly over the WiFi network.
- The Energy Gateway stores the measured data directly on the internal memory storage. Online data and history can be viewed through iHC applications (MAIRF and MIIRF). The last option is to display the measured values directly on the RFBM-2M web interface.
- Measurement of power consumption can be distinguished by up to four tariffs that can be displayed in kWh or financial costs.
- Other benefits include the ability to set the response to a specific consumption. An example may be to switch off or on the RFS-6x and CU3 outputs.
- The energy gate takes usually 10 minutes, but not more than 1 hour, depending on the volume of measured data.

## Assembly

mounting into switchboard



## Connection

connection to the tariff

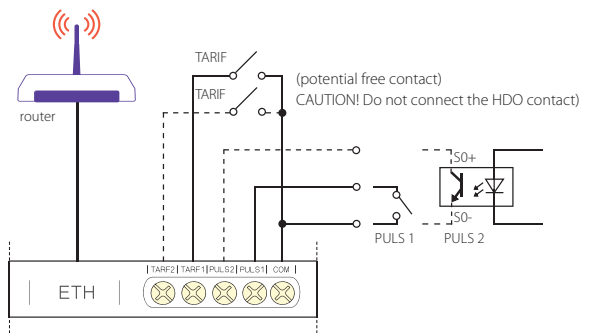

## Radio frequency signal penetration through various construction materials

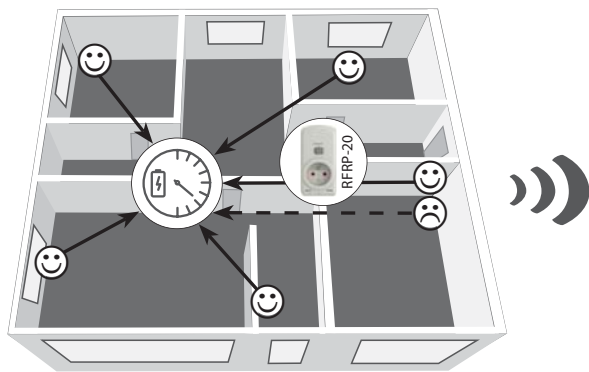

|             |                                       |                     |                  |              |
|-------------|---------------------------------------|---------------------|------------------|--------------|
|             |                                       |                     |                  |              |
| 60 - 90 %   | 80 - 95 %                             | 20 - 60 %           | 0 - 10 %         | 80 - 90 %    |
| brick walls | wooden structures with plaster boards | reinforced concrete | metal partitions | common glass |

## Description, Indication

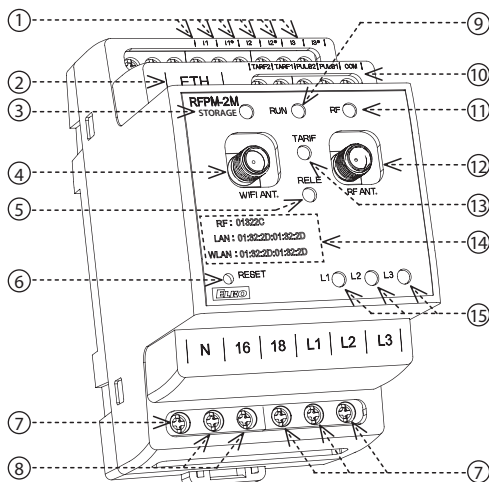

1. Terminals for connection of current measuring probes
2. Connect Ethernet
3. Storage operation indication
4. Wi-Fi antenna
5. Relay switch indication
6. RESET button:
  - Enter the bootloader - turn off the power, press the button and hold the button > 2s when the power is on
  - Return to factory settings - power off, press button and hold power button > 15s
7. Voltage and voltage terminals
8. Relay output
9. Supply voltage indication / unit status:
  - Lit - STOP status
  - Flashes - RUN status
10. Pulse and tariff inputs
11. RF communication indication
12. RF antenna
13. Tariff indication:
  - TARIFF 1: red
  - TARIFF 2: green
  - TARIFF 3: blue
  - TARIFF 4: Yellow
14. RF, LAN and WLAN addresses
15. Phase status indication L1, L2, L3:
  - Failure (redundancy): red
  - Phase active: green
  - Unmonitored phase: LED off



# RFPM-2M

EN Energy gateway



**INEL**  
RF Control  
02-5/2018 Rev.2

## Tariff

Example of wiring for two-wire connection

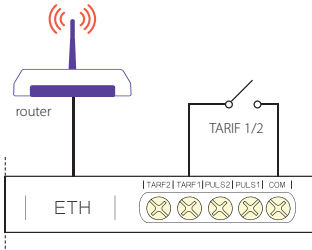

An example of using the output relay  
- phase failure monitoring  
- Excessive consumption  
- Undercover ...

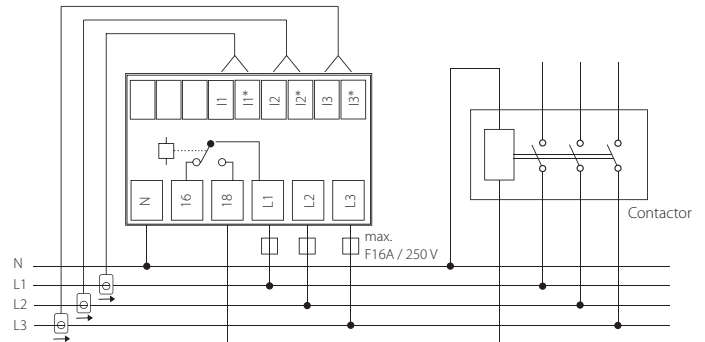

| TARIF   | Indication             | Linking                      |
|---------|------------------------|------------------------------|
| TARIF 1 | illuminated red LED    | Without wiring               |
| TARIF 2 | illuminated green LED  | TARIF 1 - COM                |
| TARIF 3 | illuminated blue LED   | TARIF 2 - COM                |
| TARIF 4 | illuminated yellow LED | TARIF 1 - COM, TARIF 2 - COM |

## Methods of sensing meters

### Scanning with the current transformer CT50

1-phase wiring

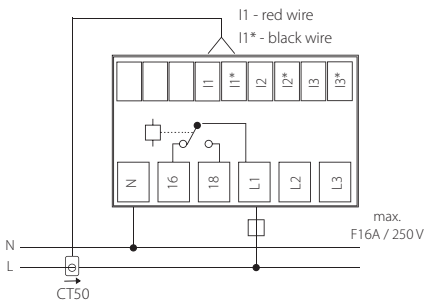

Note: The arrow inside the CT50 current transformer must be directed to the appliance.

3-phase wiring

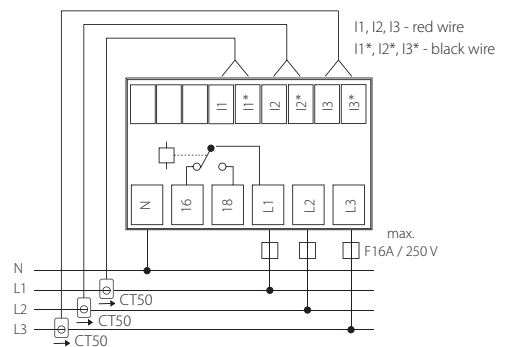

### Scanning with sensor (MS / WS / LS) and device RFTM-1

- LS - LED sensor
  - The LED sensor scans LED impulses on the meter, which indicates consumption by flashing.
  - The LED sensor is particularly suitable for power meters that support LED pulse sensing (the LED on the meter is marked "imp").
  - The sensor's scanner is affixed with glue above the LED diode of the meter signaling indication of consumption.
  - The sensor is connected to the internal terminal of the RFTM-1 converter.
- MS - Magnetic sensor
  - The magnetic sensor scans movement of the numeral, upon which a permanent magnet is placed.
  - The MS sensor is particularly suitable for gas meters that support magnetic sensing.
  - The device sensor is fastened by gluing over the last number of the dial unit measured (it may be designated on the silver reflective element number 6).
  - The sensor is connected to the internal terminal of the RFTM-1 converter.
- WS - Magnetic sensor water meter
  - A magnetic sensor that detects the pulse that is created by each rotation of the magnet placed on the unit dial meter.
  - The WS sensor is especially suitable for water meters that support magnetic sensing.
  - The sensing sensor is glued over the circular unit face of the gauge (the scanning dial is different from the other indicators, e.g. the white arrow wheel).
  - The sensor is connected to the internal terminal of the RFTM-1 converter.

Note: The standard supplied length of 1.5 m can be custom ordered in an extended version of up to 5 m.

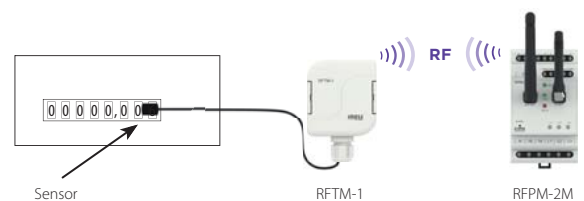



# RFPM-2M

EN Energy gateway



# INEL

RF Control

02-5/2018 Rev.2

### • Scanning with output "S0" and RFTM-1

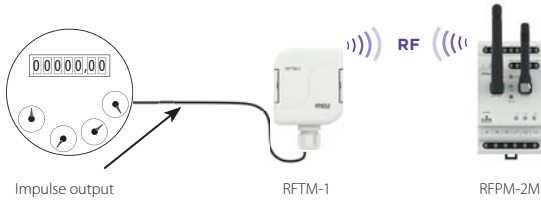

### • Scanning with output "S0"

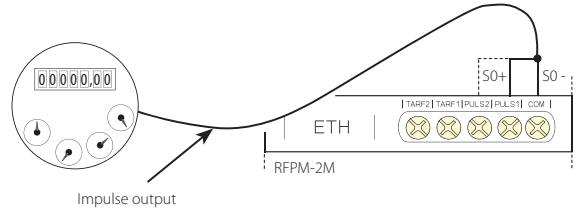

- S0 - contact, open collector, reed magnetic contact
- Impulse output meters marked "S0" connected to the GND and DATA1 terminals on the RFTM-1 sensor.
- When polarization is indicated on the meter, the terminals S0 + and S0 - must be distinguished when connected to the "S0" impulse output.

### Notice

- RFTM-1 / RFPM-2M / sensors (LS, MS, WS) do not affect the consumption meter and do not affect the measurement of the measured quantity.
- Electricity meters, water meters and gas meters are the property of energy suppliers. Without their knowledge and permission, they are not allowed to interfere with internal connections (seals, supply lines, etc.).

## Installation of RFPM-2M

Connect the RFPM-2M to the power supply (can be powered from the monitored phase).

Use an Ethernet cable to connect it to your PC / Router. By default, static IP address **192.168.1.2** is set on RFPM-2M.

If you do not have the same IP range on the router, you need to set the same IP address range in your PC (Control Panel \ Network and Internet \ Network Connections \ Local Area Connection \ Properties \ Version 4 Protocol \ Use the following IP address \ 192.168.1.10 - to make RFPM-2M available for configuration.

After this, open a web browser (supported browsers: Chrome, Firefox, Opera, Safari - other browsers may not work properly). Enter the IP address 192.168.1.2.

The RFPM-2M Web Environment opens, where you can configure your device.

RFPM-2 will require login through your username and password, which are set by default:

Name: **admin**

Password: **admin**

To successfully set the time from the NTP server, it is necessary to restart RFPM-2 after setting up its network.

In case the RFPM-2M is not connected to the Internet, the time can be updated using the "refresh" button on the web. RFPM-2M will automatically notify you of this update by a red alarm in the upper right time window.

Note: Press and hold the RFPM-2 button for 10 seconds on the front panel of the instrument (RESET). The IP address and login information will return to the factory settings.



Once logged in, you'll see an interface for managing and displaying measured data in your browser.

Graphical display of measured states

Display of currently measured states

Setting RFPM-2M

Detailed view of interactive graph

Interactive graph



Time and date settings

List of connected inputs

Signal strength

Version FW

This tab is primarily used to update the firmware.

The current firmware is available at <https://www.elkoep.com/energy-gateway---rfpm-2m>

Download the firmware by selecting a file on your computer and upload it to RFPM-2\*. After the new firmware is loaded, the power can be retrieved for several minutes.

\* Only update the firmware using a LAN connection. WiFi recording may not work correctly.



## Settings - set RFPM-2M

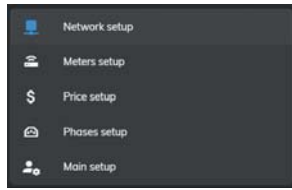

The entire RFPM2-M is divided into several parts:

- Set up a network interface that allows network communication.
- setting of RFTM-1 pulse transducers
- External RFPM-2 inputs and security settings.
- price settings
- settings for each phase
- password and currency settings

## Network interface settings

Network setup - RFPM-2M can be set as:

- **Access Point Bridge** – RFPM-2M is an Ethernet cable connected to a home router that assigns IP to all devices that connect to RFPM-2M.
- **Access Point LAN** – RFPM-2M creates a custom network that is separate from the home network. Devices can only be accessed from this network. To connect to this network, it is necessary to configure the static IP on the connected device.
- **Client LAN** – RFPM-2M is connected to a home router using DHCP or static IP. RFPM-2M acts as a terminal device and cannot be accessed directly through it.

To create a WLAN with AP Bridge / LAN, it is necessary to select Encryption (none / WPA-PSK1 / 2) to enter a password that corresponds to the standard of the given encryption (min. 8 characters). When the changes are saved, the WLAN becomes visible.

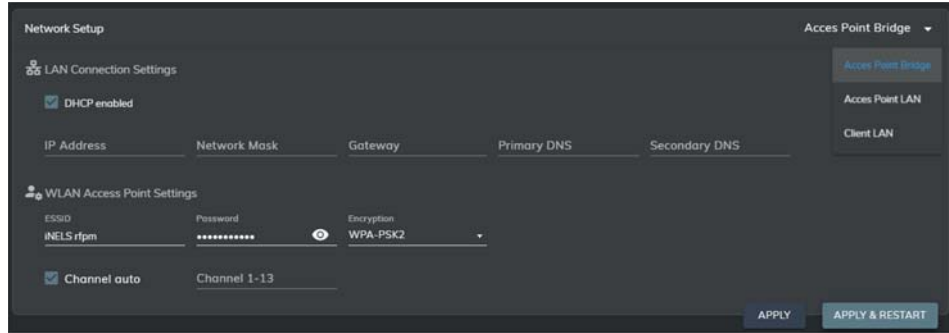

DHCP enabled - Network settings

- – IP address is set automatically
- – IP address needs to be set in the appropriate range of the connected router (filling the IP address of RFPM-2, masks, gateways and DNS).

WLAN Access Point Settings - WiFi network setup RFPM-2M

- **ESSID** – the name of WiFi created
- **Encryption** – type of security
- **Password** – must be filled in the required form for that security
- **Channel** – WiFi broadcast channel

## Setting the meters

External setup - external input S0

- **Name** – RFTM-1 name optionally chosen
- **Unit** – Unit of measurement (kW / h - for electricity measurement or m<sup>3</sup> - for water or gas measurement)
- **Pulses** – Pulse value for the measured value (the value that translates the number of pulses per unit of a given quantity) - this is given on the meter, gas meter or water meter (e.g.: 800 meters / kWh on the meter).
- **Type** – selection of measured quantity (electricity, cold water, hot water, gas)

RFTM setup - RFTM-1 input

- **+** – Add RFTM-1 converter
- **Name** – RFTM-1 name optionally chosen
- **Unit** – Unit of measurement (kW / h - for electricity measurement or m<sup>3</sup> - for water or gas measurement)
- **Type** – selection of measured quantity (electricity, cold water, hot water, gas)
- **Pulses** – Pulse value for the measured value (the value that translates the number of pulses per unit of a given quantity) - this is given on the meter, gas meter or water meter (e.g.: 800 meters / kWh on the meter).

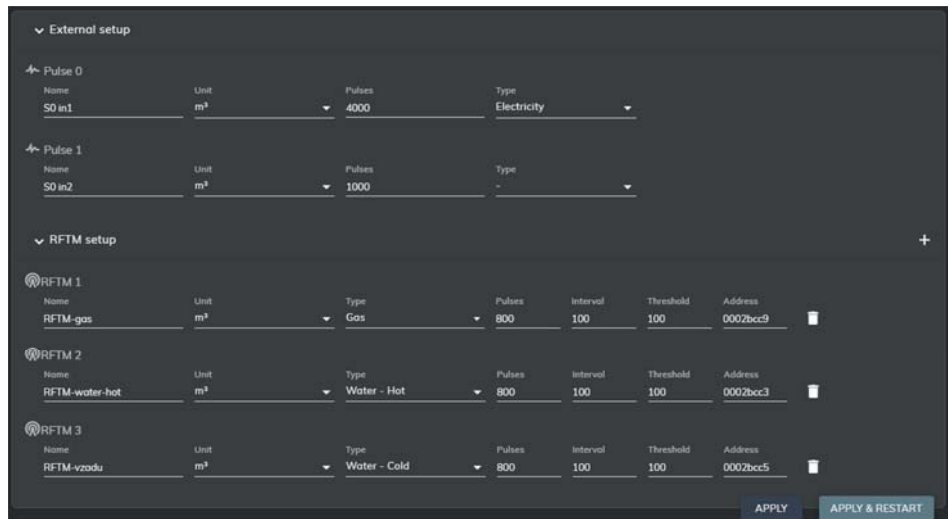

- **Interval** – After the set time interval has elapsed, RFTM-1 sends information about the magnitude of the measured value (minimum interval is 1 minute).
- **Threshold** – the pulse value pulse interval - after recording the set number of pulses RFTM-1 sends information on the size of the measured value (the minimum number of pulses is 1) - the RFTM-1 can send this information at most once per minute
- **Address** – The RF address that is listed on RFTM-1
- **Trash symbol** – RFTM-1 removal (after removing RFTM-1 and replacing it with another RFTM-1, the measured values of the original RFTM-1 remain stored in the graph, these values are then displayed as a one-off curve of the last value).
- If the saved changes are not reflected in the browser, you must refresh it.



## Setting the price

Price setting for unit of given quantity (electricity, cold water, hot water, gas)  
Price - is the default value to be calculated if no time interval is set.

- + – add a new type of energy price, this price is valid for a specific period, beyond the set period is calculated with the default price.

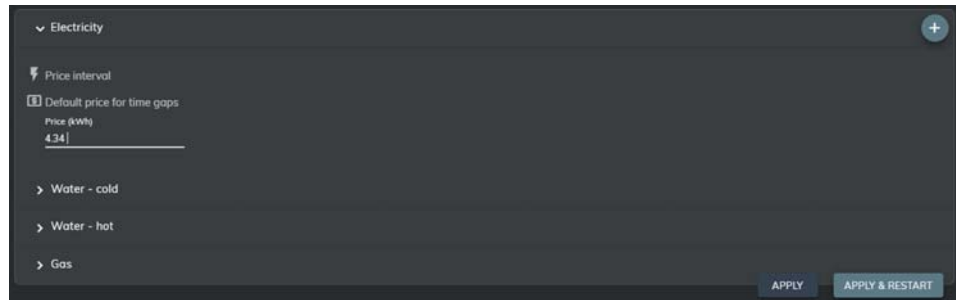

## Setting for each phase

Voltage monitoring (overvoltage, under-voltage) - sets the upper level in the range of 138-276V (overvoltage) and the lower level in the range of 35-99% of the upper level. If the phase moves from this set band, the output relay switches on / off the contact (if this function is indicated).

- **Phase L1, L2, L3** – Setting for Phase 1, Phase 2, and Phase 3
- **Threshold** – setting the limit value of the quantities
- **Hysteresis** – fixed deviation attributed to the limit value when returning to the supervised zone
- **WARN** – Activating this button activates the Warning function
- **RELAY** – by activating this button it is possible to switch the relay when the defined value is exceeded
- **Over Voltage (V)** – overvoltage
- **Under Voltage (V)** – Under-voltage
- **Phase Loss (V)** – monitors loss of voltage on individual phases
- **THD Voltage (%)**, **THD Current (%)** – percentage deviation expressing distortion from ideal harmonic flow.
- **Asymmetry (%)** – the asymmetry rate between the phases is set at 5-20%. If the set asymmetry is exceeded, the relay can be switched on / off.

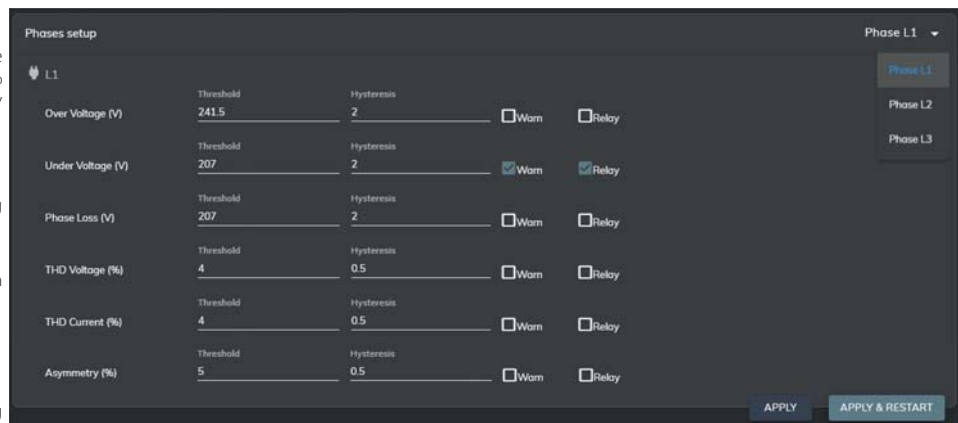

## Main setup

- Web interface
- Currency setup
- Tarrif setup
- Timezone setup
- Device Name

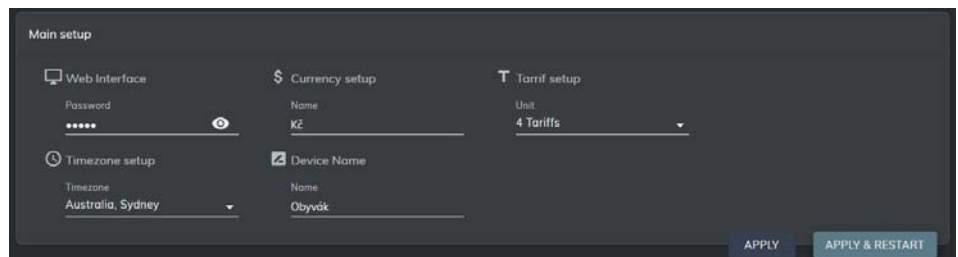



## Online Data

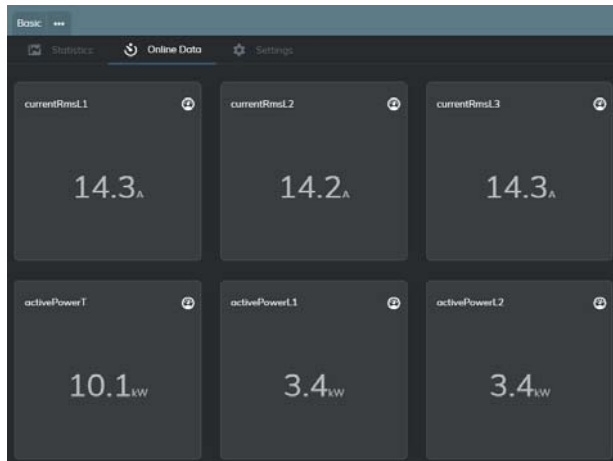

**Basic** - basic display of current states

**Advanced** - extended display of current states

**Personalized** - display of actual states of selected measured quantities

| Measured quantities                | L1+L2+L3          | L1                 | L2                 | L3                 |
|------------------------------------|-------------------|--------------------|--------------------|--------------------|
| Phase current                      | currentRms0       | currentRmsL1       | currentRmsL2       | currentRmsL3       |
| Phase voltage                      | -                 | voltageRmsL1       | voltageRmsL2       | voltageRmsL3       |
| Asymmetry                          | -                 | asymmetryL1        | asymmetryL2        | asymmetryL3        |
| Distortion of the sine wave signal | -                 | thdnVoltageL1      | thdnVoltageL2      | thdnVoltageL3      |
| Distortion sine wave signal flow   | -                 | thdnCurrentL1      | thdnCurrentL2      | thdnCurrentL3      |
| Frequency                          | frequency         | -                  | -                  | -                  |
| Active performance                 | activePowerT      | activePowerL1      | activePowerL2      | activePowerL3      |
| Reactive power                     | reactivePowerT    | reactivePowerL1    | reactivePowerL2    | reactivePowerL3    |
| Apparent performance               | apparentPowerT    | apparentPowerL1    | apparentPowerL2    | apparentPowerL3    |
| Power factor                       | powerFactorT      | powerFactorL1      | powerFactorL2      | powerFactorL3      |
| Power fundamental harmonic         | fundamentalPowerT | fundamentalPowerL1 | fundamentalPowerL2 | fundamentalPowerL3 |
| Performance of other harmonics     | harmonicPowerT    | harmonicPowerL1    | harmonicPowerL2    | harmonicPowerL3    |
| Phase voltage shift between phases | -                 | voltageAngleB      |                    | voltageAngleC      |
| RFPM-2M indoor temperature         | temperature       |                    |                    |                    |
| Phase shift of voltage and current | -                 | PowerAngleA        | PowerAngleB        | PowerAngleC        |

Display of actual states of selected measured quantities

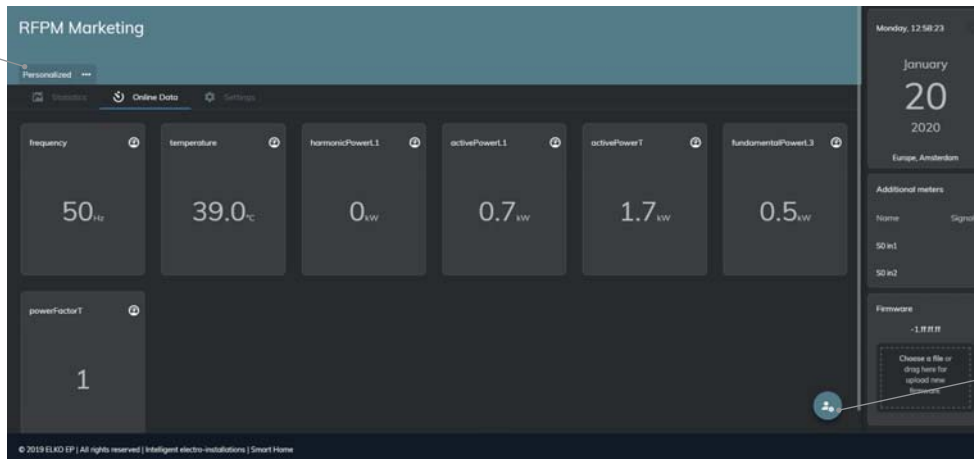

Enter selection for display

List of measured quantities

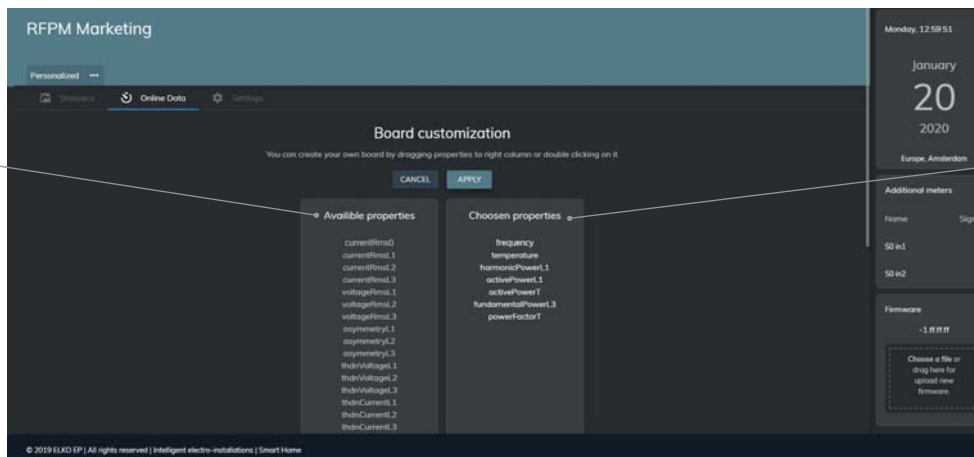

Selection for display

To make a selection, double-click the desired quantity in the list or drag it to the selection. Click Apply to save your selection.



## Statistics - Graphical display of measured states

Selection of measured energy sources (consumed electricity / supplied electricity / SO inputs / RFTM -1)

Total value measured today

Power consumption visualization

Display of measured electricity in individual tariffs

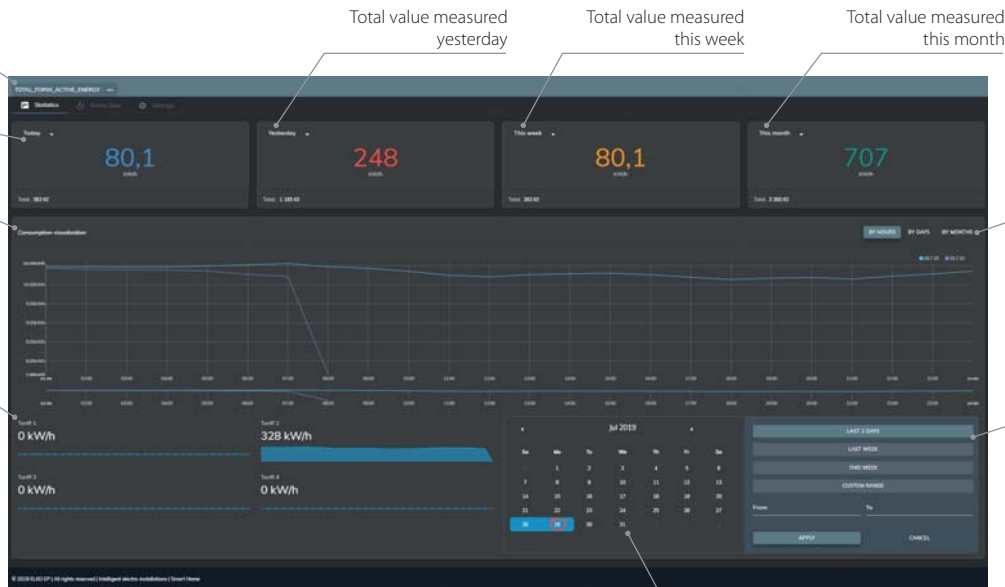

Total value measured yesterday

Total value measured this week

Total value measured this month

Choosing to display graphs by hours, days, and months

Selection of time period for graph visualization

View the date range

Every 5 minutes, the data is automatically refreshed and the page is updated.

## Mobile App

Measured data can also be displayed in iHC application.

- For an Android mobile phone: You download the current version on iGo-MAIRF on Google Play. [https://play.google.com/store/apps/details?id=en.elkoep.ihc\\_marf\\_us&hl=en](https://play.google.com/store/apps/details?id=en.elkoep.ihc_marf_us&hl=en)

iHC-MAIRF



For more information about RFPM-2 settings in mobile applications, see the manual of these applications, which can be found on [www.elkoep.com](http://www.elkoep.com) or directly in the applications.



## Technical parameters

|                                                        |                                                      |
|--------------------------------------------------------|------------------------------------------------------|
| Supply / measured voltage:                             | 230 V AC / 50-60 Hz, 1f / 3f +N                      |
| Supply voltage tolerance:                              | +15/-20%                                             |
| Closed relay power input:                              | 5 VA                                                 |
| Switching voltage level:                               | 140V, +10/-20%                                       |
| <b>Output RELE</b>                                     |                                                      |
| Number of contacts:                                    | 1 NO/NC switches L1                                  |
| Max. current:                                          | 16 A / AC1                                           |
| Switching power:                                       | 4000 VA (AC1)                                        |
| Mechanical service life:                               | 3 x 10 <sup>7</sup>                                  |
| Electrical service life:                               | 0.7 x 10 <sup>5</sup>                                |
| Relay reaction:                                        | two-way addressed message, see manuals               |
| <b>Interface RF Control</b>                            |                                                      |
| Communication protocol:                                | RF Touch Compatible                                  |
| Broadcasting frequency                                 | 866 MHz, 868 MHz, 916 MHz                            |
| Signal transfer method:                                | two-way addressed message                            |
| Output for antenna:                                    | SMA - FEMALE*                                        |
| Antenna RF:                                            | 1 dB (part of suply)                                 |
| Range in open space:                                   | up to 100 m                                          |
| <b>Controlling</b>                                     |                                                      |
| Controlling:                                           | WEB / Mobile Applications                            |
| Button Reset:                                          | Bootloader (stisk >2 s) / Unit reset (press >10 s)   |
| <b>Interface Wi-Fi</b>                                 |                                                      |
| Wi-Fi mode:                                            | AP Bridge / AP LAN / Client                          |
| Standard:                                              | IEEE 802.11 b/g/n / 2.4 GHz                          |
| Wi-Fi Security:                                        | WEP, WPA-PSK, WPA2-PSK                               |
| Frequency range Wi-Fi:                                 | RP - SMA - FEMALE*                                   |
| Antenna Wi-Fi:                                         | 1 dB (part of suply)                                 |
| Range:                                                 | up to 20 m                                           |
| <b>Interface Ethernet</b>                              |                                                      |
| Network settings:                                      | static IP / DHCP Client                              |
| Transfer speed:                                        | 10 / 100 Mbit / s                                    |
| Connector:                                             | RJ45                                                 |
| Default IP address / IP address of bootloader:         | 192.168.1.2                                          |
| <b>Measuring</b>                                       |                                                      |
| Pulse inputs:                                          | PULS1 (S0), PULS2 (S0)                               |
| Tariff inputs:                                         | TARF1, TARF2 - binary combination                    |
| Option of switching inputs:                            | switching by contact/opening by collector            |
| Separation by isolation of power and control circuits: | reinforced Insulation (Cat. II surges by EN 60664-1) |
| Probes measuring current:                              | 3 x CT-50                                            |
| Wireless consumption sensor:                           | RFTM-1                                               |
| <b>Measuring circuit</b>                               |                                                      |
| Network:                                               | 1f-3f                                                |
| Frequency:                                             | 50 - 60 Hz / ±10 %                                   |
| Accuracy:                                              | Class 1.0                                            |
| Current measuring coil:                                | max. 50 A (current transformer CT50)                 |
| Wire diameter:                                         | max. 16 mm                                           |
| <b>Other data</b>                                      |                                                      |
| Working temperature:                                   | -20 .. +35°C                                         |
| Storage temperature:                                   | -30 .. +70°C                                         |
| Operating position:                                    | vertical                                             |
| Mounting:                                              | DIN rail EN60715                                     |
| Protection:                                            | IP20 from front panel / IP40 in cover                |
| Overvoltage category:                                  | II.                                                  |
| Degree of pollution:                                   | 2                                                    |
| Cross-section of connecting wires (mm <sup>2</sup> ):  | max. 1x 2.5, max. 2x 1.5 / with a hollow max. 1.5    |
| Dimension:                                             | 90 x 52 x 65 mm                                      |
| Weight:                                                | 125 g                                                |

\* Max Tightening Torque for antenna connector is 0.56 Nm.

Attention:

When you instal iNELS RF Control system, you have to keep minimal distance 1 cm between each units. Between the individual commands must be an interval of at least 1s.

## Notification and saving changes

Save any changes you have made by pressing APPLY or APPLY & RESTART. If the change needs to be restarted, it will request it.

Notification of successful download

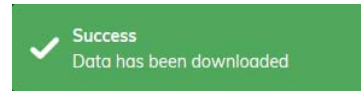

Notification of successful data storage

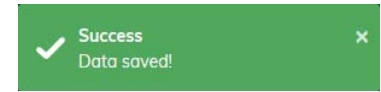

Notification of incorrect data download

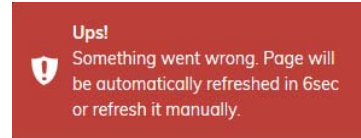

Notification of failed data storage

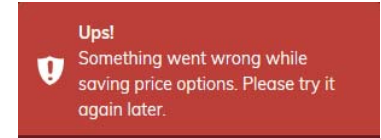

Data download notification

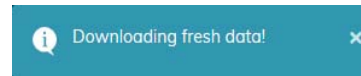

Notification of forced restart after data saving

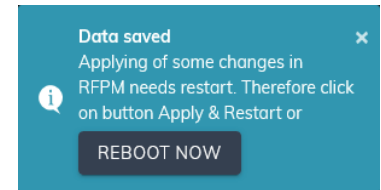

Notification of successful update of FW and restart of web page after 15 sec

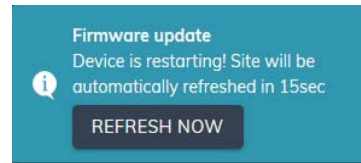

Notification of restart of RFPM and refresh of web page after 15 sec

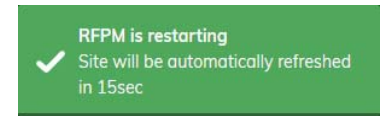

Recalculation of new data (browser freezes when new data is downloaded)

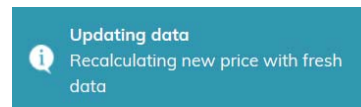

## Warning

Instruction manual is designated for mounting and also for user of the device. It is always a part of its packing. Installation and connection can be carried out only by a person with adequate professional qualification upon understanding this instruction manual and functions of the device, and while observing all valid regulations. Trouble-free function of the device also depends on transportation, storing and handling. In case you notice any sign of damage, deformation, malfunction or missing part, do not install this device and return it to its seller. It is necessary to treat this product and its parts as electronic waste after its lifetime is terminated. Before starting installation, make sure that all wires, connected parts or terminals are de-energized. While mounting and servicing observe safety regulations, norms, directives and professional, and export regulations for working with electrical devices. Do not touch parts of the device that are energized – life threat. Due to transmissivity of RF signal, observe correct location of RF components in a building where the installation is taking place. RF Control is designated only for mounting in interiors. Devices are not designated for installation into exteriors and humid spaces. The must not be installed into metal switchboards and into plastic switchboards with metal door – transmissivity of RF signal is then impossible. RF Control is not recommended for pulleys etc. – radiofrequency signal can be shielded by an obstruction, interfered, battery of the transceiver can get flat etc. and thus disable remote control.